

## Installation and Operating Instructions **CE**

0093.158.00

### VISULEX Cameras K55-HD and K55-4K

• **Description:**

The VISULEX camera K55-HD/K55-4K is a camera with fixed lens. With this standard camera, the lens is fixed to the object to be observed during installation (outdoor area/outdoor plant or also process control technical process parts such as boiler or agitators).

The temperatures specified in the data sheet for the camera type must be observed for fault-free operation.

The power supply (Power over Ethernet) is provided exclusively via the network cable supplied (max. 60 m).

• **Design and field of application:**

- Pressure-resistant stainless steel housing with built-in HD/4K network camera, electronics and stainless steel bracket

• **General electrical and technical data:**

- Camera supply voltage: PoE  
- Maximum power consumption: 5 W  
- Protection class of the camera: IP65 according to EN 60529/  
DIN VDE 0470 part 1

• **Marking:**

The camera is permanently, visibly and legibly identified by a nameplate with the following information.

- Name and address of the manufacturer  
- Camera type: K55-HD/K55-4K  
- Ambient temperature range: 0°C to +40°C  
- Production number/year of manufacture  
- Supply voltage  
- Power consumption  
- Protection class IP65  
- CE mark



VISULEX camera K55-HD  
mounted on a flange with hinged bracket

The warnings given in the labelling must be observed.

• **Camera and/or electronics change:**

A possible exchange of the camera assembly takes place exclusively by the manufacturer or in the factory of the manufacturer (F.H. Papenmeier GmbH & Co. KG).

## Connection cable:

- ETHERLINE® Cat. 7 FLEX outer sheath PUR with UL approval; construction 4x2xAWG26/7
- Length: max. 60 m (197 ft) at 100 Mbps; max. 60 m (197 ft) at 10 Gbps
- The connection cable must be laid in such a way that a static charging is avoided. The length of the network cable must be at least 1 m (3.3 ft).

## • Connection of the camera K55-HD/K55-4K:

- Connect the camera using the standard RJ-45 cable the network connection.
- For the connection to a PC, generally a crossover cable is required, while for connection to a switch a direct cable (patch cable) is used.
- For power supply of the camera a switch with the PoE (Power over Ethernet) function can be used.
- Connect the camera directly to your PoE switch. (Power supply of the camera is only possible via PoE). If your switch does not have the PoE Function, a PoE injector is required.

- The IP address is automatically assigned via DHCP. If there is no DHCP server in your network, the default IP address is 192.168.1.10.
- To configure the camera, both devices should be (camera and PC) in the same IP address range (e.g. camera 192.168.1.10, desktop 192.168.1.11).
- To view the live image in the highest quality the Internet Explorer is recommended (Safari, Mozilla Firefox, Opera and Google Chrome are also supported).
- Notice: To view streaming video in Microsoft Internet Explorer, set your browser to allow ActiveX controls.

## • Access using a browser:

1. Start a browser.
2. Enter the IP address or the host name of network camera in the URL field (address line) of your browser.
3. The home page appears. Click Live View (real-time monitoring), Playback (playback) or setup (configuration) to call up the corresponding web page.

To provide access to the camera, the password for the default administrator must be set. This is done in the „Admin Password“ dialog that is displayed the first time you open the Network Camera Configuration. Enter your Admin Name and Password set by the administrator.

**Note:** The default name and password of the administrator is „admin“.

### Default Login

Username: admin  
Password: admin

If the password has been lost, the network camera must be reset to the factory settings. See „Resetting to factory settings“.

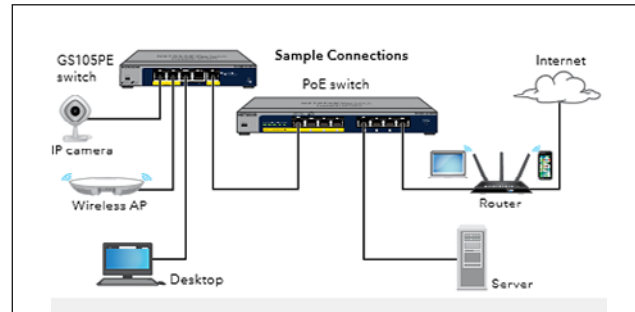

Installation example for a network with PoE switch

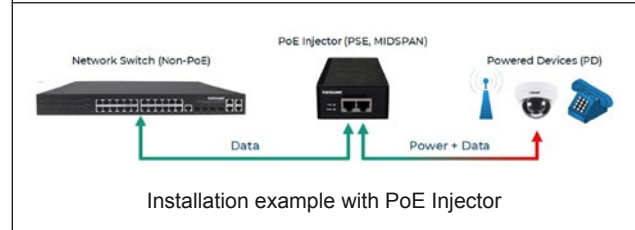

Installation example with PoE Injector



Start page view in the browser

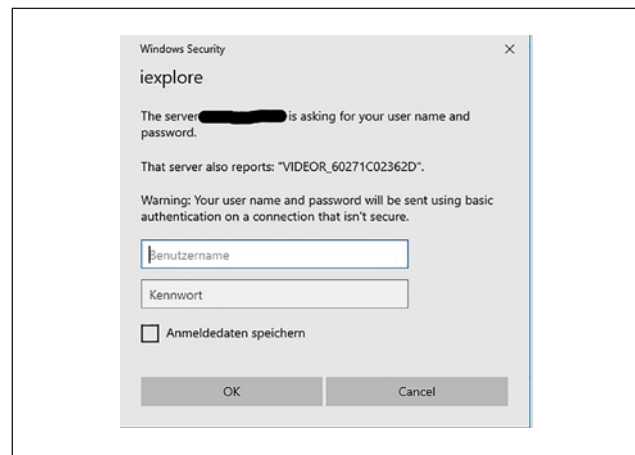

Dialog „Admin password“



Setup home page of the camera

- **Language selection**

To change the national language, switch to System → Language

- **Activate DHCP or change IP address**

System → Network → Basic

- **Factory settings**

To reset the network camera to the factory settings, call on the web page Configuration → System → Maintenance.

**Note:** When resetting to factory settings your individual settings will be lost. (Default IP: 192.168.1.10)

- **Live View page**

The Live View page can be displayed in different modes.

The users can select one for them suitable modes.

Please set the mode according to the performance of your PC and the required monitoring purpose.

- **General control elements**

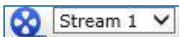

Use the video drop-down list to display a configured or pre-programmed video stream on the Live View page. The stream profiles are defined under Setup (Configuration) → Basic Configuration → Video and Picture configured.

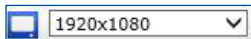

From the drop-down list resolutions, you can select the most appropriate resolution on the Live View page.



In the protocols drop-down list, you can select which combination of protocols and methods you want to use, depending on your display requirements and the properties of your network.

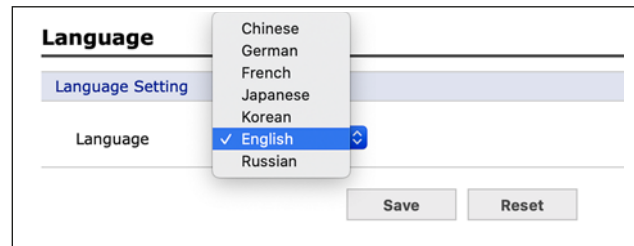

Dialog „Language selection“

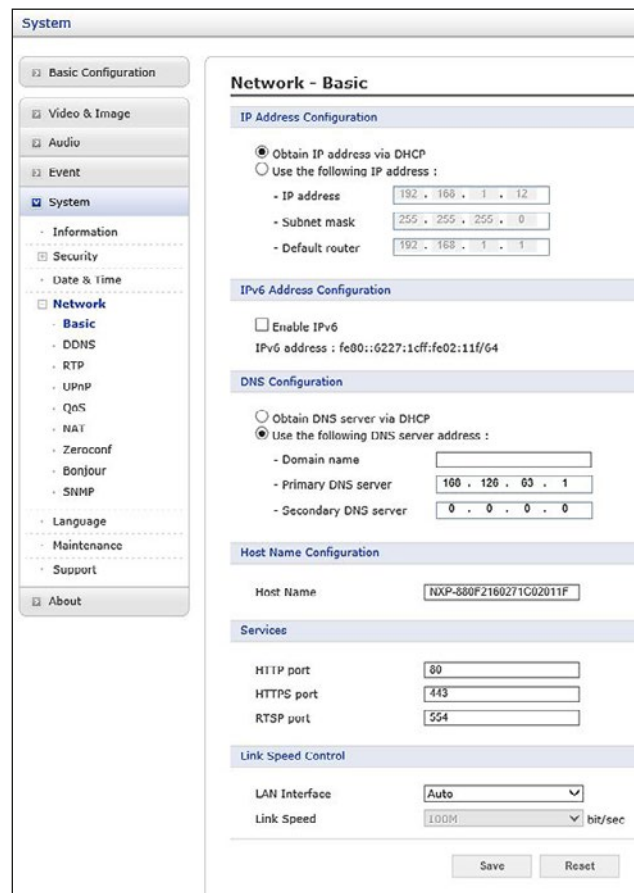

Dialog „Activate DHCP or change IP address“



Live View page

• **Dimensions for VISULEX cameras K55-HD and K55-4K:**

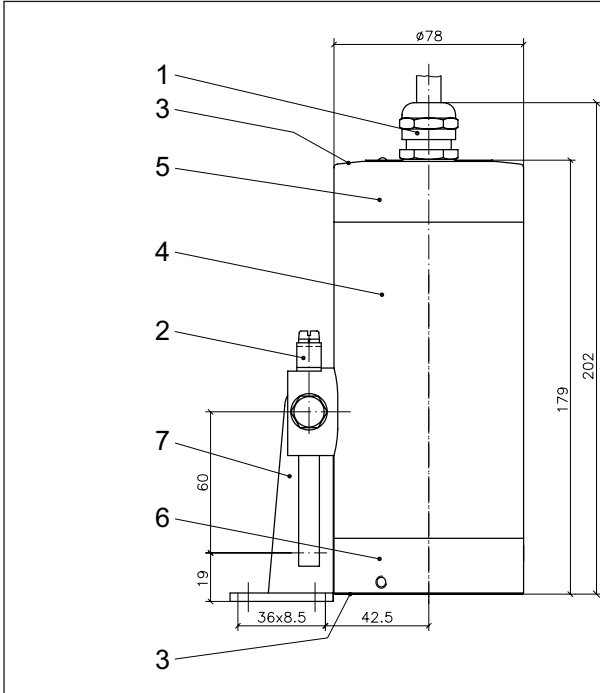

- 1 Cable entry gland M20x1.5
- 2 External protection conductor terminal
- 3 Locking screws M4 A2-70
- 4 Camera body
- 5 End cover
- 6 Sight glass
- 7 Mounting attachment (hinged bracket)

• **Mechanical assembly:**

Before installation, please also make sure that you observe the Information sheet 'Important information on the use of Sight glass fittings'.

The camera is mounted with the mounting parts on the cover flange of a round sight glass or flow sight glass or fixed on the groove nut of screwed sight glass fittings.

Attention: Under no circumstances may direct sunlight enter the lens of the camera may come into contact with the lens, as this will render the camera unusable.

• **The camera K55-HD/K55-4K is suitable for nominal sizes with the appropriate mounting:**

Type of fitting	from DN	Hinged bracket	Flanged adapter
Circular sight glass fitting DIN 28120 + DIN 28121	40	+	-
Flow indicator sight glasses	50	+	-
Screw-type sight glass fitting in compliance with DIN 11851	65	-	+
	80	+	+
	100	+	+
	125	+	+

• **Mounting with hinged bracket:**

The hinged bracket is used to mount the camera to a cover flange of a circular sight glass fitting or a flow sight glass or on the slotted nut for screw - Sight glass fittings DIN 11851.

The hinged bracket is fastened to the required bolt circle with the screw „M8“ supplied with the hinge for a threaded blind hole to be drilled by the customer beforehand. Alternatively, the hinged bracket can be welded on.

• **Mounting with flanged adapter collar:**

The flanged adaptor is mounted on the slotted cover nut (DIN 11851) (welded or screwed connection).The camera is fixed to the flange with the screws supplied.

• **Replacement parts:**

Part	Part No.
Sight glass	1773.024.00
O-ring seal	0862.090.00

• **Accessories:**

Part	Part No.
Camera mounting (hinged bracket)	0354.025.00
Camera mounting (insert flange) MV 50	1356.038.00
Camera mounting (insert flange) MV 65	1356.039.00
Camera mounting (insert flange) MV 80	1356.040.00
Camera mounting (insert flange) MV 100	1356.044.00
Camera mounting (insert flange) MV 125	1356.041.00

• **Maintenance:**

- Keep the camera clean
- After opening the camera, the surfaces of the cylindrical gap between the end cover (5) and the camera lens (6) should be cleaned. Before assembling the camera again, check that the components are undamaged and relubricate them (e.g. with AEMA-SOL 6 B, from A.E. Matthes)
- Regular cleaning of the glass plate for optimal Camera view
- Use only OEM spare parts