



Lumistar Luminaire USL 05 LED-Ex

 II 2G Ex db IIC T6 Gb
 II 2D Ex tb IIIC T80°C Db

• Important note:

Sight glass luminaires are intended for a specific purpose and are designed exclusively for mounting on or onto sight glass flange sockets. Under no circumstances may a sight glass lamp replace the mating flange or the complete sight glass flange socket or be used directly to cover a container opening. Luminaires for hazardous areas may only be installed, connected and maintained by specially trained and authorised personnel. It is essential to observe the data of the EU type-examination certificate!



Caution: Do not look into light – danger of impaired eyesight!

• General operating conditions:

- Independent of vessel internal pressure/vacuum – approved for use in Ex areas:
 Gas: Zones 1 and 2
 Dust: Zones 21 and 22
- Approved for use in ambient temperatures from -20°C up to +60°C or up to +50°C, depending on capacity

• Electrical data, general:

- Voltage, power, temperature class and degree of protection can be found on the nameplate.
- Ex approval according to EU type examination certificate:
 BVS 08 ATEX E 133

 II 2G Ex db IIC T6 Gb
 II 2D Ex tb IIIC T80°C Db

• Connection data: Temperature data assignment and electrical parameters (see also EU type-examination certificate)

Item	USL 05 LED-Ex	Variant with 2 m connection cable part no.	Variant with cable gland 7-11 mm part no.	Ambient temperature range			
				-20°C ≤ T _a ≤ +50°C		-20°C ≤ T _a ≤ +60°C	
1	230 V AC – 4 W	3540.059.00	–	–	–	2G T6	2D T80°C
2	24 V AC/DC – 7.5 W	3540.042.00	3540.935.00	2G T6	2D T80°C	–	–
3	110-230 V AC – 7.5 W	3540.043.00	3540.936.00	2G T6	2D T80°C	–	–

• Electrical connection:

Conditions: The Ex luminaire is manufactured with a permanently connected cable. The free ends of the connecting cable must be installed in a category 2G/2D enclosure if the connection is made in a potentially explosive atmosphere.

Before installation or repair, the luminaire and the area where it is to be installed must be cleaned of dust. The dismantled parts must be protected from contamination during installation or repair. When closing the luminaire, make sure that the interior of the luminaire is free of dust.

The connection line for the pressure-tight cast connection line is already connected in the luminaire by the manufacturer and ready for operation. For an externally tested and approved cable entry (M20x1.5), the cable connection must be made in the luminaire.

The external protective conductor terminal (pos. 1) must be connected to separate operating earth. The connecting cable must be intercepted after a maximum of 1 m.

Attention! When replacing cables (e.g. other lengths), the inner connections must be loosened before unscrewing the cable entry. The connecting cable must be laid in such a way that static charging is excluded.



Lumistar luminaire USL 05 LED-Ex

• Module change:

- Make the luminaire voltage-free
- Observe waiting time according to type plate
- Loosen locking screw (pos. 2) for screwed glass (pos. 4); loosen the locking tab (pos. 3)
- Unscrew the screw glass (pos. 4) with the assembly key
- Press LED briefly, turn and pull out
- Insert the spare bulb into the bayonet, press it on and lock it by turning it briefly. Pay attention to correct fit!
- Before closing the lamp, regrease the thread of the screw-on glass (e.g. with AEMA-SOL 6 B, manufacturer A. E. Matthes)
- Screw in the screwed glass (pos. 4) until it is tight again (pressure against the O-ring)
- Safety tab (pos. 3) must engage in one of the notches so that the screwed glass (pos. 4) is locked
- Tighten the locking screw (pos. 2) again
- Apply voltage

Lumiglas

• Connection and lens change:

- Switch luminaire voltage-free
- Observe the waiting time according to the type plate
- Loosen the locking screw (2) for the screw glass (4); this releases the locking tab (3)
- Unscrew the screw glass with the mounting key

• Lens change:

- Press the retaining clip slightly outwards and simultaneously push the lens up. See photo 1.
- Loosen the fastening screws from the lens holder and remove the lens holder. See photo 2.
- Pull out the module
- Connect power supply
- Reinsert the module. See photo 3.
- Mount lens holder
- Insert lens
- Before closing the lamp, re-grease the thread of the screw-on glass (e.g. with AEMA-SOL 6 B, manufacturer A. E. Matthes)
- Screw the screw-in glass (pos. 4) back in until tight (pressure against the O-ring)
- Locking bracket must engage in the groove provided for this purpose so that the screw glass is locked in place
- Retighten locking screw (pos. 2)
- apply voltage

• Mechanical installation:

In the case of the round sight glass fitting and the flow-through sight glass, the luminaire is attached to the mating flange with the hinged bracket. In the case of the screw sightglass fitting, the luminaire is fastened to the slotted nut, alternatively by means of a hinged bracket or plug-in flange.

• The Lumistar luminaire USL 05 LED-Ex is suitable for sight glasses in the following nominal sizes, using the appropriate mounting:

Type of fitting	from DN	Hinged bracket	Flanged ad. collar
Circular sight glass fitting DIN 28120	25	yes	no
Circular sight glass fitting DIN 28121	40	yes	no
Tubular sight glass fitt.	50	yes	no
Screw-type sight glass fitting similar to DIN 11851	65	yes	yes
	80	yes	yes
	100	yes	no
	125	yes	no

• Mounting by way of hinged bracket:

The hinged bracket is used to secure the luminaire to the mating flange of a circular sight glass fitting (also suitable for visual flow indicators). Alternatively, it can be attached to the slotted cover nut of screw-type sight glass fittings to DIN 11851. The hinged bracket is fixed in place by turning the supplied M6 bolt into a blind hole which has previously been tapped in the pitch circle of the mating flange face. An additional option is to weld on the bracket.

• Mounting by way of flanged adapter collar:

The flanged adapter collar is bolted or welded to the slotted cover nut (DIN 11851).

• Please note:

Fastening and mounting elements, claw spanner, etc. should be ordered separately if needed.

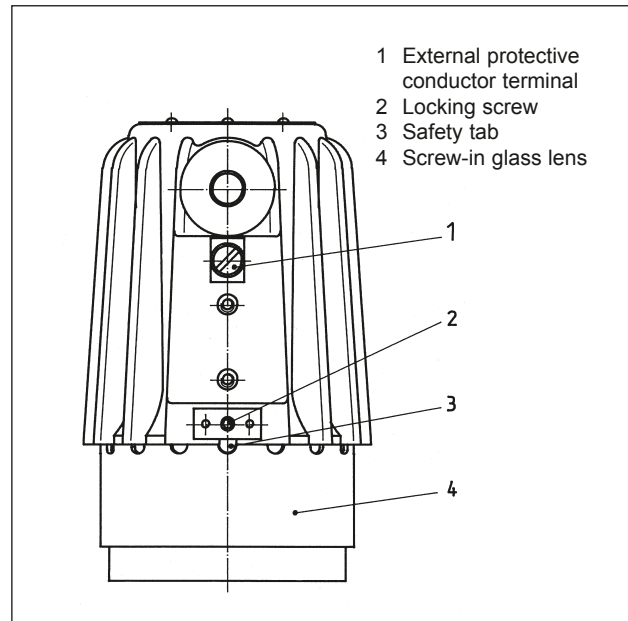

Halteklammern

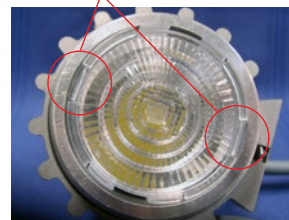

photo 1

Befestigungsschrauben

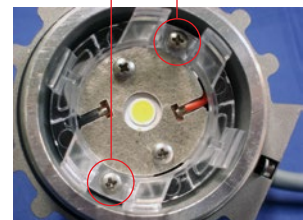

photo 2



photo 3

• Replacement parts:

Screw-type lens (light aperture) 7.5 W	Part no. 1774.128.00
Screw-type lens (light aperture) 4 W	1774.030.00
O-ring seal (Viton)	0862.114.00
Lamp socket, GZ10	1202.024.00
Cable gland 7-11 mm	9103.123.00

LED module 24 V AC/DC – 7.5 W	3858.032.00
LED module 110-230 V AC – 7.5 W	3858.040.00
LED module 230 V AC – 4 W	3233.004.00

Cable entry gland complete with 2 m connecting cable	1084.013.00
complete with 5 m connecting cable	1084.015.00
complete with 20 m connecting cable	1084.017.00

• **Accessories:** Claw spanner 6816.001.00

• Maintenance:

- Keep luminaire clean
- Only use original spare parts